

**Code Disclaimer**  
 -These plans were designed to meet IRC 2021 at the time of their creation and more specifically the minimal local codes of the central Virginia area. It is highly recommended that these plans be reviewed by a local structural engineer prior to construction.  
 -Beams and floor joists are not sized due to the many geographical locations these plans are sold. These items shall be sized by a local engineer or manufacturer.  
 -All Ceilings & Floor Joists (Provided conventional framing is used) should be sized using the latest version of the IRC or applicable codes as site to meet the local requirements such as snow loads and other factors. The ceiling joist sizes labeled (if present) were sized using the 2018 IRC at the time of their creation. They must be verified and modified as required to meet the latest edition of the International Residential Code.  
 -All Foundations and footing details shall be reviewed and approved by a local engineer.  
 -Contractor shall provide all high wind strapping and anchor bolts as required by the local code requirements and the latest version of the IRC.

DRAWING INDEX	
Sheet #	Contents
A0	Title page
A1	Foundation Plan
A2	Main Level Floor Plan
A3	Top Level Floor Plan
A4	Front & Rear Elevations
A5	Left & Right Elevations
A6	Roof Plan
C1	Cut Sections
E1	Electrical Plan
F1	Framing Plan



**SHEET:**  
**A0**  
**SCALE:**

**DRAWING ID:**

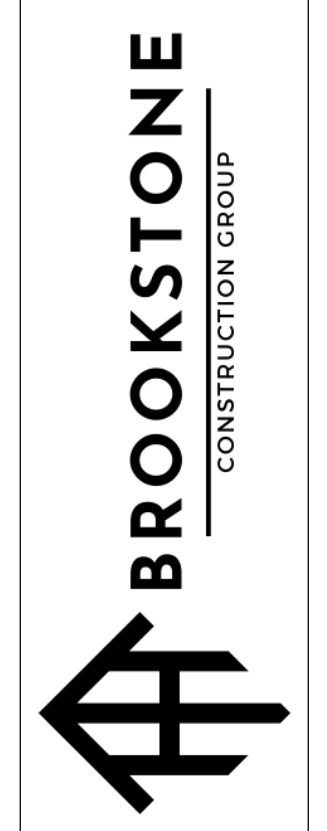

<b>Bedrooms:</b>	<b>4</b>	<b>Heated Living Space</b>	<b>3,081 SQ.FT.</b>
<b>Bathrooms:</b>	<b>3.5</b>	<b>Main Level</b>	<b>2,547 SQ.FT.</b>
<b>Foundation:</b>	<b>Slab</b>	<b>Top Level</b>	<b>534 SQ.FT.</b>
		<b>Unheated Living Space</b>	<b>915 SQ.FT.</b>
		<b>Garage</b>	<b>883 SQ.FT.</b>
		<b>Mech. Room</b>	<b>32 SQ.FT.</b>
		<b>Porch &amp; Deck Space</b>	<b>405 SQ.FT.</b>
		<b>Stoop</b>	<b>82 SQ.FT.</b>
		<b>Rear Porch</b>	<b>323 SQ.FT.</b>

**Gratis Road**  
 Custom House Plans  
 Designer: Scott M. Turner

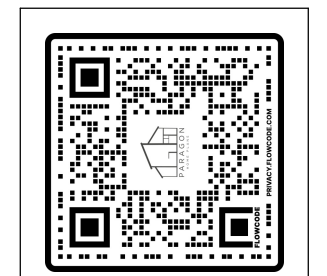

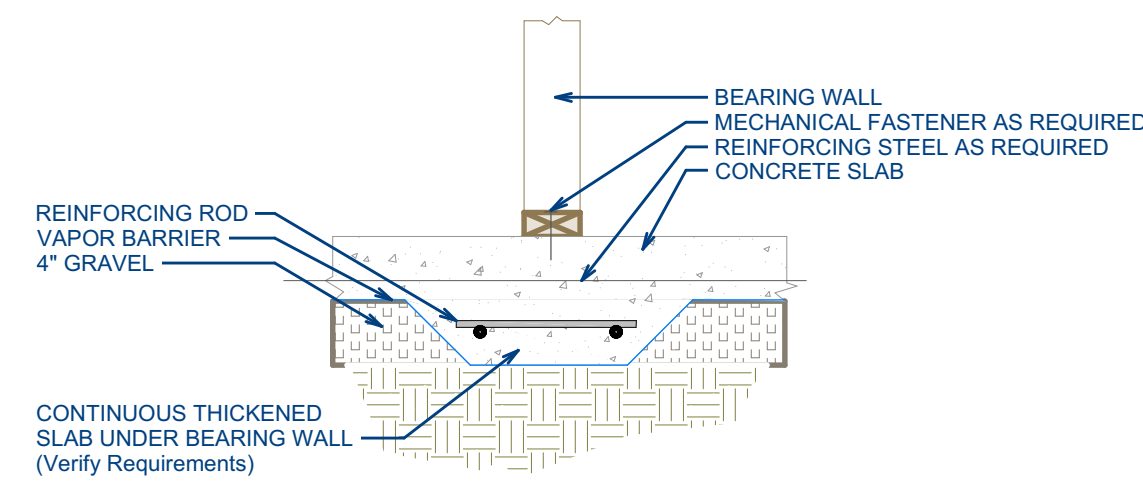
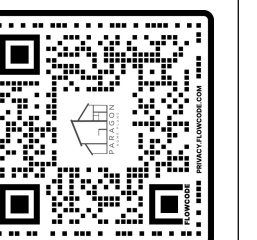

**Concrete Thickened Slab Footing**

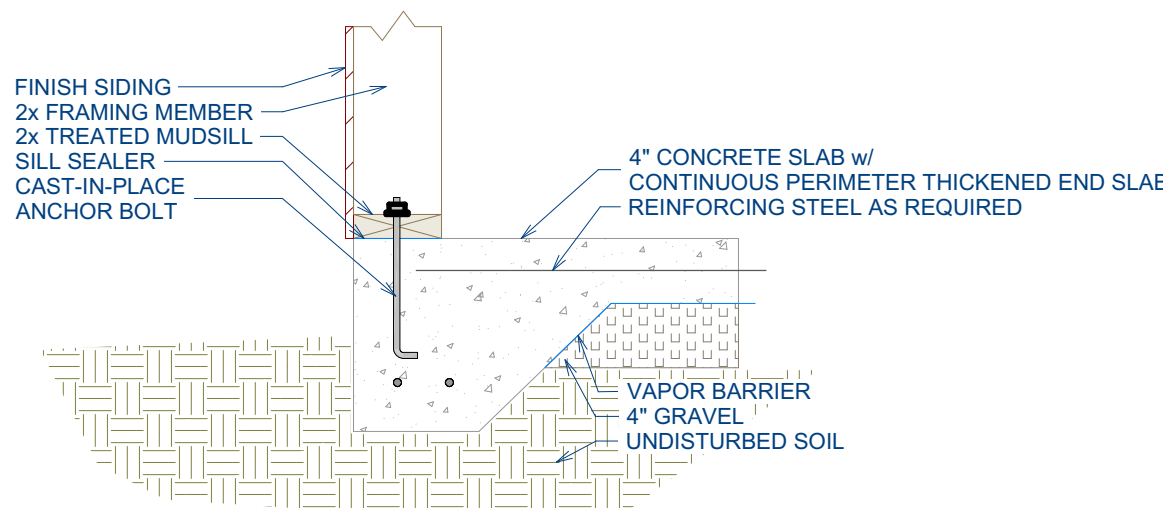

**Thickened End Slab**

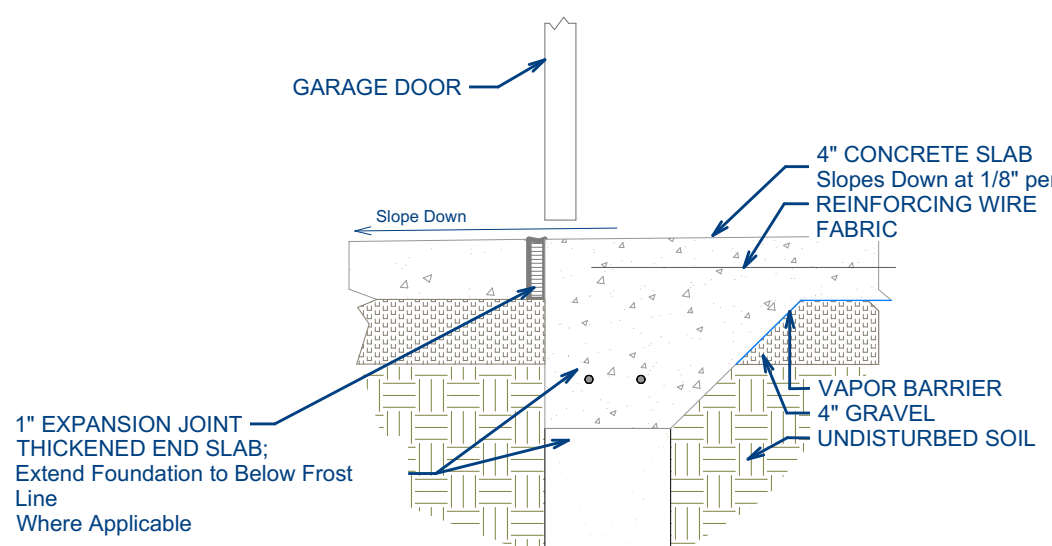

**Turned Down Slab at Garage Opening**

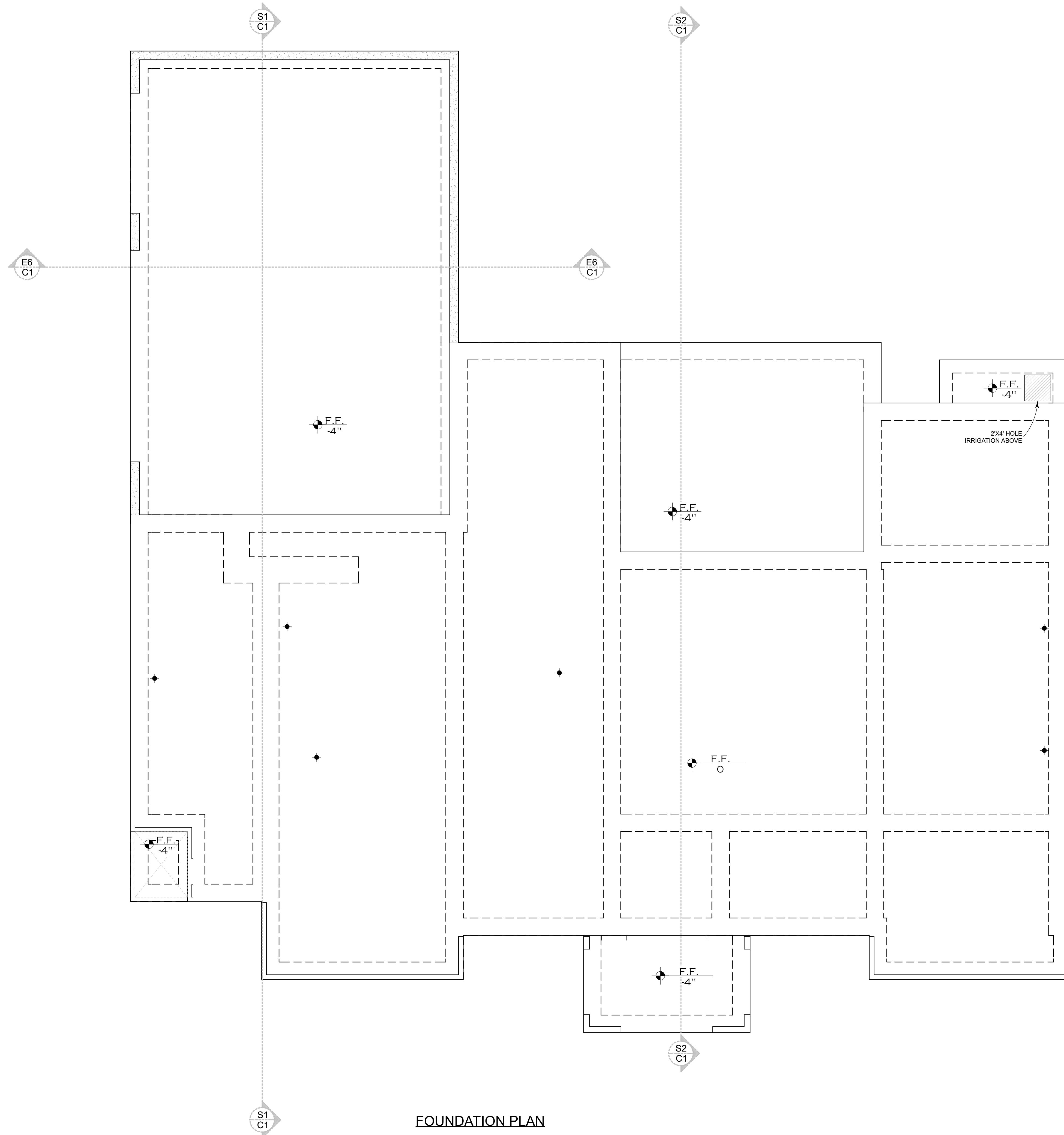

**FOUNDATION PLAN**

- Notes:
- footing sizes to meet local codes.
  - sizes are recommended, but depths will vary depending on terrain of lot.
  - minimum (4) #5 rebars for all load bearing footings
  - stiffener footings add rigidity to the slab to break up large spans.
  - minimum (2) #5 rebar for stiffener footing.
  - squaring chord measured from outermost corners of concrete/basement

**Foundation Notes**

- All Footing Sizes and locations to be verified by a licensed by a structural engineer.
- Contractor to adapt plans as required to meet all applicable codes at site.
- Contractor shall verify all dimensions with floor plan prior to construction and make any necessary adjustments.
- Contractor to provide waterproofing as required to meet all applicable codes and typical building practices.
- Concrete slabs to be 4" (3000 psi MIN.), Reinforced as per code or as determined by licensed engineer.
- Contractor to provide adequate drainage based on existing site conditions. Verify with local building codes.
- Refer to floor joist manufacturer for joist sizing and spacing, cross bracing requirements, and beam sizes.
- Provide joists under all walls running parallel.

**General Construction Notes**

- It is the responsibility of the builder to comply with and adapt this plan to satisfy the applicable International Residential Code (IRC) and energy code requirements as well as local building codes where this home plan is constructed and adapt this plan to its actual site location.
- This home and its design must be constructed by a licensed and reputable builder with experience in constructing this type of home.
- All sub-contractors used in the construction of this home must be licensed with the state and qualified to perform the work required.
- It is the Responsibility of the builders to review and perform all due diligence on this plan.
- The selection and condition of lumber used in construction may vary widely, as does the quality of the workmanship. The designer of these plans has no knowledge of the workmanship or construction methods and practices used during the construction of this project and is therefore held harmless from the design or performance of the lumber in completed structures.
- All structural material used to construct this home must meet current code requirements, certified & designed by the manufacturer or by a licensed structural engineer.
- Any Structural & Floor Joist notation on this plan is intended for purchase of design only & in no way indicated final structural requirements for load bearing locations which are designed by others.
- All load bearing locations must be reviewed, designed, & approved by lumber manufacturer or structural engineer prior to the start of construction.
- Easements & Setbacks as determined by a licensed surveyor. It is recommended that a certified structural engineer review the framing construction to verify structural integrity.
- These plan do not show or suggest final required construction practices.

**Floor Plan Notes**

-All Dimension & Site Conditions to be verified by contractor prior to construction.  
 -All Finishes (Interior & Exterior) to be verified with owner prior to construction.  
 -Verify all door & window styles & sizes with owner prior to construction. Manufacturer to supply all rough opening sizes.  
 -Contractor to verify all clearances of all doors, windows and other items that are critical prior to construction.  
 -Contractor to adapt plans as required to meet all applicable codes at site.  
 -All beams to be sized by a licensed structural engineer.  
 -Porches, Balconies or raised floor surfaces located more than 30 inches above the floor or grade below at any point within 36 inches horizontally shall have guards not less than 36 inches in height. Open sides of stairs with a total rise of more than 30 inches above the floor or grade below shall have guards no less than 34 inches in height measured vertically from the nosing of the treads. Insect screening shall not be considered as a guard. IRC 2021, R312.1.1 & R312.1.2  
 -M1305.1.3 Appliances in attics. Attics containing appliances shall be provided with an opening and a clear and unobstructed passageway from the opening to the appliance. The passageway shall have continuous solid flooring in accordance with chapter 5 not less than 24 inches wide. A level service space at least 30 inches deep and 30 inches wide shall be present along all sides of the appliance where access is required. The clear access opening dimensions shall be a minimum of 20 inches by 30 inches, and large enough to allow removal of the large appliance.  
 Exceptions:  
 a. The passageway and level service space are not required where the appliance can be serviced and removed through the required opening.  
 b. Where the passageway is unobstructed and not less than 6 feet high and 22" wide for its entire length, the passageway shall not be more than 50 feet long.  
 -Appliance access for inspection, service, repair and replacement without removing permanent construction, other appliances, or any other piping or ducts not connected to the appliance being inspected, serviced, repaired or replaced. A level working space at least 30" x 30" shall be provided in front of the control side to service an appliance. Installation of room heaters shall be permitted with at least an 18 inch working space. A platform shall not be required for room heaters.  
 M1305.1.1 Furnaces and air handlers within compartments or alcoves shall have a minimum working space clearance of 3 inches along the sides, back and top with a total width of the enclosing space being at least 12 inches wider than the furnace or air handler. Furnaces having a firebox open to the atmosphere shall have at least a 6 inch working space along the front combustion chamber side. Combustion air openings at the rear or side of the compartment shall comply with the requirements of chapter 17.  
 Exception: This section shall not apply to replacement appliances installed in existing compartments and above where the working space clearances are in accordance with the equipment or appliances manufacturer's installation instructions.  
 -Emergency escape and rescue openings shall be operational from the inside of the room without the use of keys tools or special knowledge. Window opening control devices complying with ASTM F 2090 Shall be permitted for use on windows servicing as a required emergency escape and rescue opening. All sleeping rooms to have an exterior access through a door or window with a minimum of 5.7 square feet net clear opening as per IRC 2021 R310.2.1 Exception: Grade floor or below grade openings shall have a minimum net clear opening of 5 square feet. Maximum sill height to be 44 inches. Minimum net clear opening height to be 24 inches. Minimum net clear opening width to be 20 inches.  
 -All Return air grills are to be located to comply with section M1602 of the IRC 2021.  
 -All Square footage measurements are approximate and may differ from actual constructed residence building.  
 Fire sprinkler system to be designed and installed (if required by local codes) as per the IRC 2021 and by a licensed professional in the area of construction.  
 -All bathroom exhaust vents shall be vented directly to the exterior of the home and not into the the attic. IRC 2021, M1507.2

DOOR SCHEDULE			
FLOOR	QTY	SIZE	TYPE
1	1	2080 R	SHOWER
1	1	2480 R	POCKET
1	1	2680 L	POCKET
1	1	2680 R	POCKET
1	1	2480 L IN	HINGED
1	2	2680 L IN	HINGED
1	1	2680 R IN	HINGED
1	3	2880 L IN	HINGED
1	4	2880 R IN	HINGED
1	1	3068 R EX	HINGED
1	2	3080 L IN	HINGED
1	1	16080	GARAGE
1	1	3080	GARAGE
1	1	3080 L/R IN	DOUBLE HINGED
1	1	5080 L/R IN	DOUBLE HINGED
1	1	6080 L/R EX	DOUBLE HINGED
1	1	12090 L EX	0+4-PANEL SLIDER

WINDOW SCHEDULE			
FLOOR	QTY	SIZE	TYPE
1	3	2040SH	SINGLE HUNG
1	15	2860SH	SINGLE HUNG
1	1	1026LV	LOUVERED
1	1	2640FX	FIXED GLASS
1	4	2820FX	FIXED GLASS
1	1	4040FX	FIXED GLASS
1	2	2860DH	DOUBLE HUNG

Residence to be constructed in accordance with the 2021 IRC. Structure to be continuously sheathed per IRC Section R602.10, Method CS-WSP.

**Window Notes**

-Tempered windows where required as per code.  
 -Fixed Windows where applicable as per code/owner.  
 -Egress Windows as required as per code.  
 -Window sizes/rough openings may vary by manufacturer. Adjust header accordingly prior to construction determined by others.

**General Construction Notes**

-It is the responsibility of the builder to comply with and adapt this plan to satisfy the applicable International Residential Code (IRC) and energy code requirements as well as local building codes where this home plan is constructed and adapt this plan to its actual site location.  
 -This home and its design must be constructed by a licensed and reputable builder with experience in constructing this type of home.  
 -All sub-contractors used in the construction of this home must be licensed with the state and qualified to perform the work required.  
 -It is the Responsibility of the builders to review and perform all due diligence on this plan.  
 -The selection and condition of lumber used in construction may vary widely, as does the quality of the workmanship. The designer of these plans has no knowledge of the workmanship or construction methods and practices used during the construction of this project and is therefore held harmless from the design or performance of the lumber in completed structures.  
 -All structural material used to construct this home must meet current code requirements, certified & designed by the manufacturer or by a licensed structural engineer.  
 -Any Structural & Floor Joist notation on this plan is intended for purchase of design only & in no way indicated final structural requirements for load bearing locations which are designed by others.  
 -All load bearing locations must be reviewed, designed, & approved by lumber manufacturer or structural engineer prior to the start of construction.  
 -Easements & Setbacks as determined by a licensed surveyor. It is recommended that a certified structural engineer review the framing construction to verify structural integrity.  
 -These plans do not show or suggest final required construction practices.

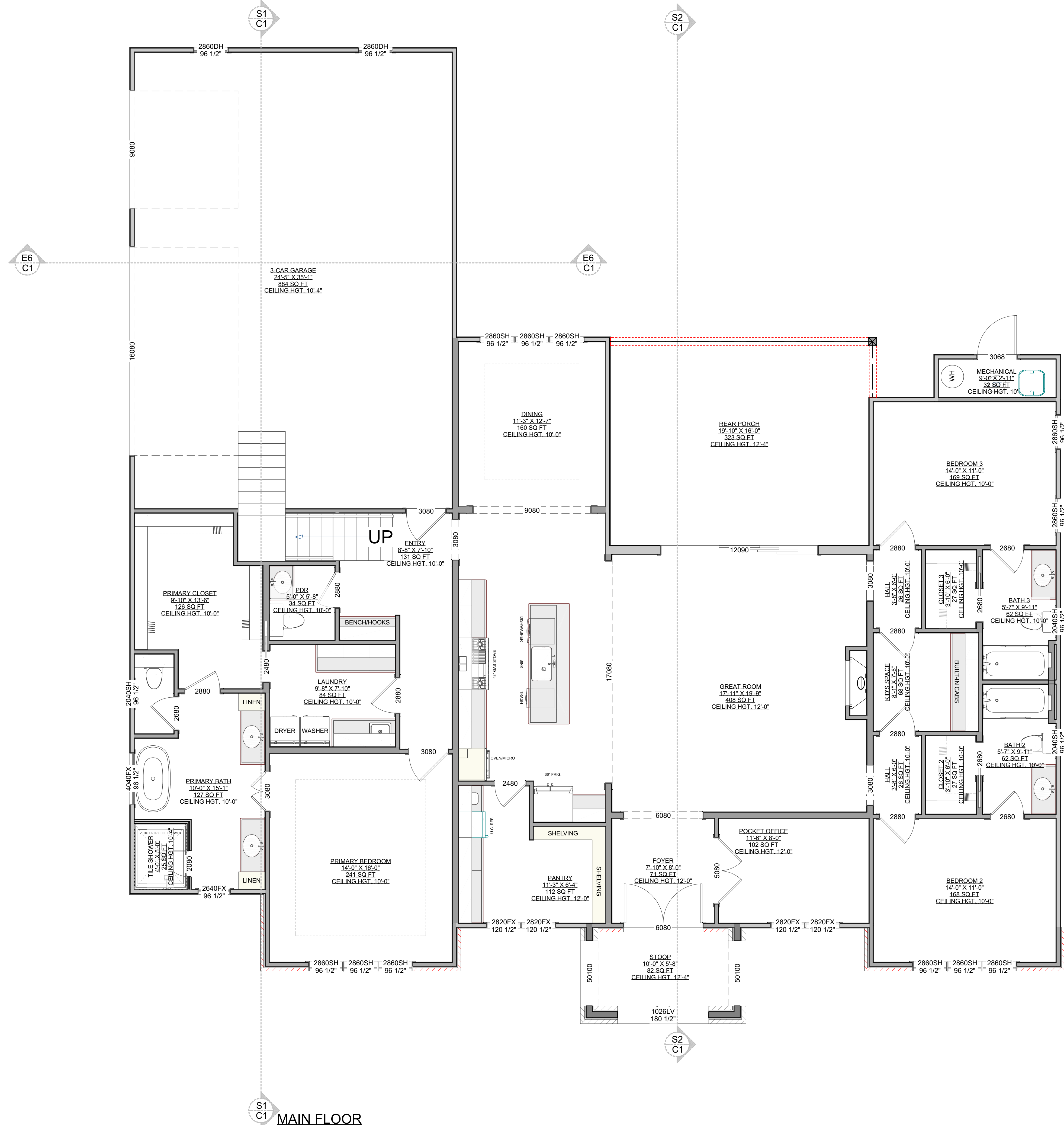



**Exterior Elevation Notes**

- Contractor to verify all window & Door Styles & Sizes with owner prior to construction.
- Provided steps and guard rails as per code based on site conditions.
- Ground lines shown are for reference only and vary depending on site conditions.
- All Finish materials to be verified with owner prior to construction.
- Refer to typical wall detail for framing methods and other Misc. information.
- Contractor to provide adequate roof ventilation as required by current codes.



FRONT ELEVATION



REAR ELEVATION

**General Construction Notes**

- It is the responsibility of the builder to comply with and adapt this plan to satisfy the applicable International Residential Code (IRC) and energy code requirements as well as local building codes where this home plan is constructed and adapt this plan to its actual site location.
- This home and its design must be constructed by a licensed and reputable builder with experience in constructing this type of home.
- All sub-contractors used in the construction of this home must be licensed with the state and qualified to perform the work required.
- It is the Responsibility of the builders to review and perform all due diligence on this plan.
- The selection and condition of lumber used in construction may vary widely, as does the quality of the workmanship. The designer of these plans has no knowledge of the workmanship or construction methods and practices used during the construction of this project and is therefore held harmless from the design or performance of the lumber in completed structures.
- All structural material used to construct this home must meet current code requirements, certified & designed by the manufacturer or by a licensed structural engineer.
- Any Structural & Floor Joist notation on this plan is intended for purchase of design only & in no way indicated final structural requirements for load bearing locations which are designed by others.
- All load bearing locations must be reviewed, designed, & approved by lumber manufacturer or structural engineer prior to the start of construction.
- Easements & Setbacks as determined by a licensed surveyor. It is recommended that a certified structural engineer review the framing construction to verify structural integrity.
- These plan do not show or suggest final required construction practices.



SHEET:  
**A4**  
SCALE:  
**1/4"**

DRAWING ID:

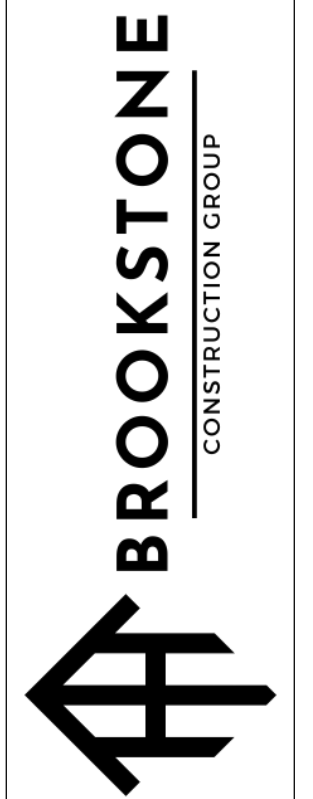

**Gratis Road**  
Custom House Plans  
Designer: Scott M. Turner

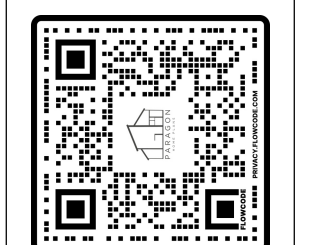

**Exterior Elevation Notes**

- Contractor to verify all window & Door Styles & Sizes with owner prior to construction.
- Provided steps and guard rails as per code based on site conditions.
- Ground lines shown are for reference only and vary depending on site conditions.
- All Finish materials to be verified with owner prior to construction.
- Refer to typical wall detail for framing methods and other Misc. information.
- Contractor to provide adequate roof ventilation as required by current codes.



**RIGHT ELEVATION**



**LEFT ELEVATION**

**General Construction Notes**

- It is the responsibility of the builder to comply with and adapt this plan to satisfy the applicable International Residential Code (IRC) and energy code requirements as well as local building codes where this home plan is constructed and adapt this plan to its actual site location.
- This home and its design must be constructed by a licensed and reputable builder with experience in constructing this type of home.
- All sub-contractors used in the construction of this home must be licensed with the state and qualified to perform the work required.
- It is the Responsibility of the builders to review and perform all due diligence on this plan.
- The selection and condition of lumber used in construction may vary widely, as does the quality of the workmanship. The designer of these plans has no knowledge of the workmanship or construction methods and practices used during the construction of this project and is therefore held harmless from the design or performance of the lumber in completed structures.
- All structural material used to construct this home must meet current code requirements, certified & designed by the manufacturer or by a licensed structural engineer.
- Any Structural & Floor Joist notation on this plan is intended for purchase of design only & in no way indicated final structural requirements for load bearing locations which are designed by others.
- All load bearing locations must be reviewed, designed, & approved by lumber manufacturer or structural engineer prior to the start of construction.
- Easements & Setbacks as determined by a licensed surveyor. It is recommended that a certified structural engineer review the framing construction to verify structural integrity.
- These plan do not show or suggest final required construction practices.



**SHEET:**  
**A5**  
**SCALE:**  
**1/4"**

**DRAWING ID:**

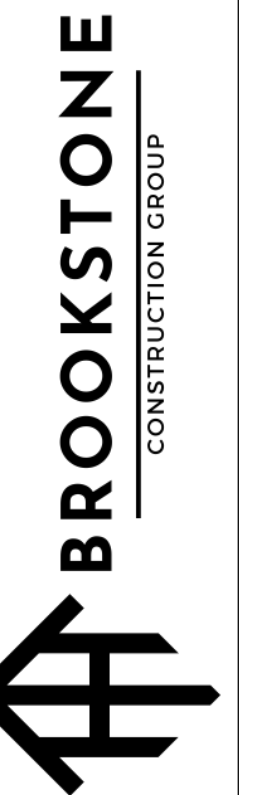

**Gratis Road**  
Custom House Plans  
Designer: Scott M. Turner

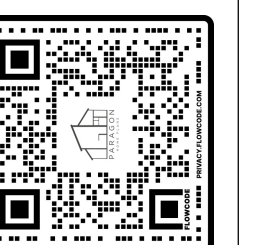

**PARAGON**  
HOME PLANS

**Roof Plan Notes**

- Contractor shall comply with all applicable codes as site.
- All ridge beams, hip rafters, & Valley Rafters to be 2"X10", No.2 S.Y.P. or as required by engineer.
- All rafters to be sized as per span chart
- Contractor to waterproof all roof intersections as per code
- Contractor to verify all roof intersections with exterior elevations prior to construction.
- Contractor to provide adequate roof ventilation as required by current codes.

**Rafter Length Chart**

Roof Pitch	Factor
3/12	1.05
4/12	1.07
5/12	1.10
6/12	1.14
7/12	1.17
8/12	1.20
9/12	1.25
10/12	1.30
11/12	1.35
12/12	1.40
14/12	1.54
16/12	1.70

Multiply Horizontal Span of Member by factor. Chose Appropriate Factor by Roof Pitch

**Hip/Valley Conversion**

Slope (Degrees)	Rise/Run	Slope (Degrees)
5	1/17	3
10	2/17	7
14	3/17	10
18	4/17	13
23	5/17	16
27	6/17	19
30	7/17	22
34	8/17	25
37	9/17	28
40	10/17	30
42	11/17	33
45	12/17	35

This Chart does not apply to Dual Pitch Roofs

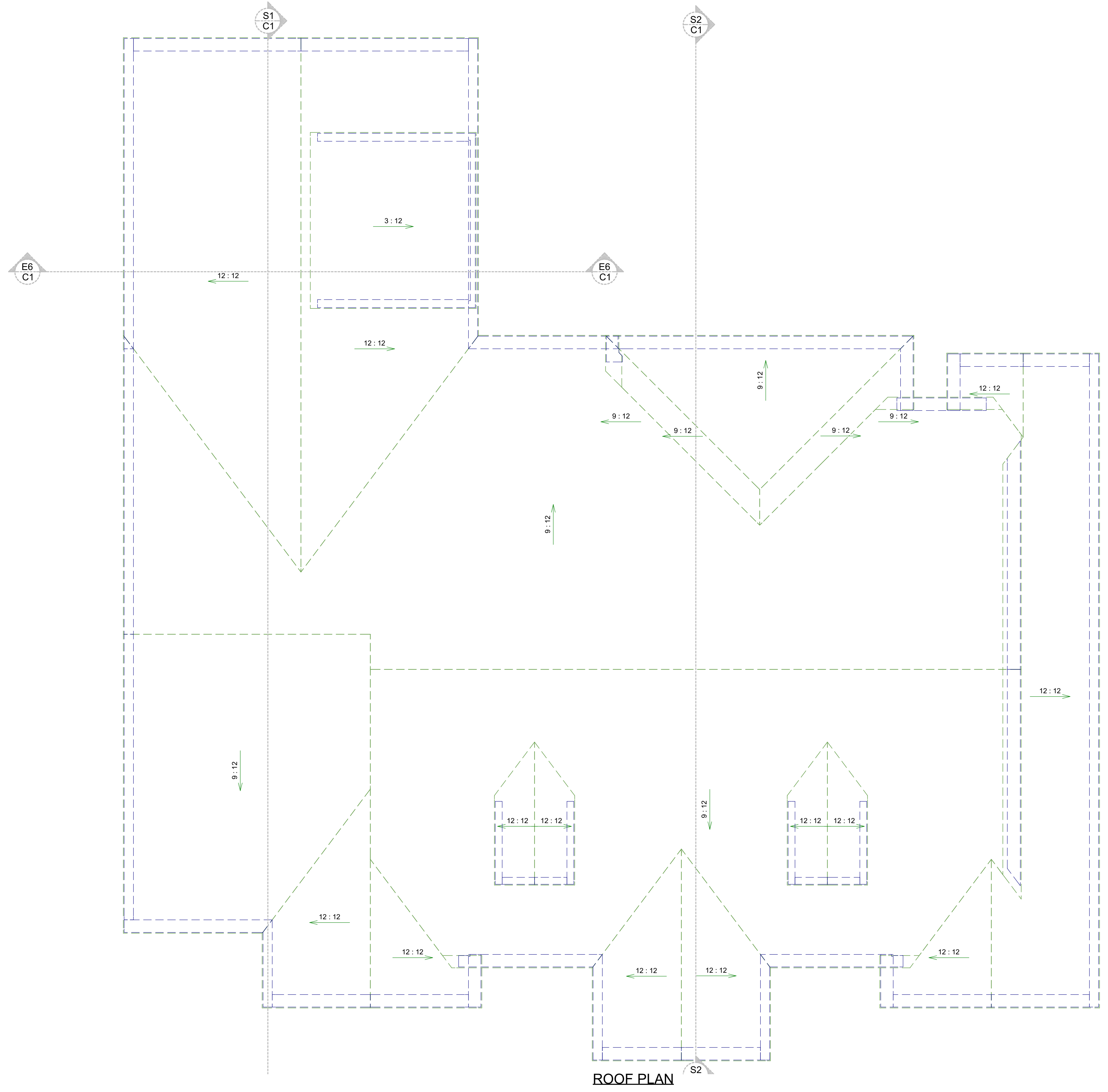

**ROOF PLAN**

Residence to be constructed in accordance with the 2021 IRC. For rafter sizing and allowable span, refer to IRC Tables R802.4.1 (1-8) & IRC Figures R301.2(2-3) for local wood species and snow load requirements.

**General Construction Notes**

- It is the responsibility of the builder to comply with and adapt this plan to satisfy the applicable International Residential Code (IRC) and energy code requirements as well as local building codes where this home plan is constructed and adapt this plan to its actual site location.
- This home and its design must be constructed by a licensed and reputable builder with experience in constructing this type of home.
- All sub-contractors used in the construction of this home must be licensed with the state and qualified to perform the work required.
- It is the Responsibility of the builders to review and perform all due diligence on this plan.
- The selection and condition of lumber used in construction may vary widely, as does the quality of the workmanship. The designer of these plans has no knowledge of the workmanship or construction methods and practices used during the construction of this project and is therefore held harmless from the design or performance of the lumber in completed structures.
- All structural material used to construct this home must meet current code requirements, certified & designed by the manufacturer or by a licensed structural engineer.
- Any Structural & Floor Joist notation on this plan is intended for purchase of design only & in no way indicated final structural requirements for load bearing locations which are designed by others.
- All load bearing locations must be reviewed, designed, & approved by lumber manufacturer or structural engineer prior to the start of construction.
- Easements & Setbacks as determined by a licensed surveyor. It is recommended that a certified structural engineer review the framing construction to verify structural integrity.
- These plan do not show or suggest final required construction practices.



**SHEET:**  
**A6**  
**SCALE:**  
**1/4"**

**DRAWING ID:**

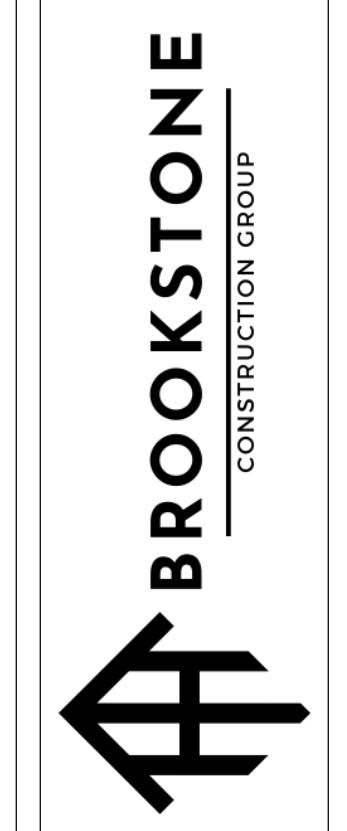

**Gratis Road**  
Custom House Plans  
Designer: Scott M Turner

